

1

2

3

4

A

B

C

D

E

A

B

C

D

E

kotnierz/flange/Фланец

DN125 PN16

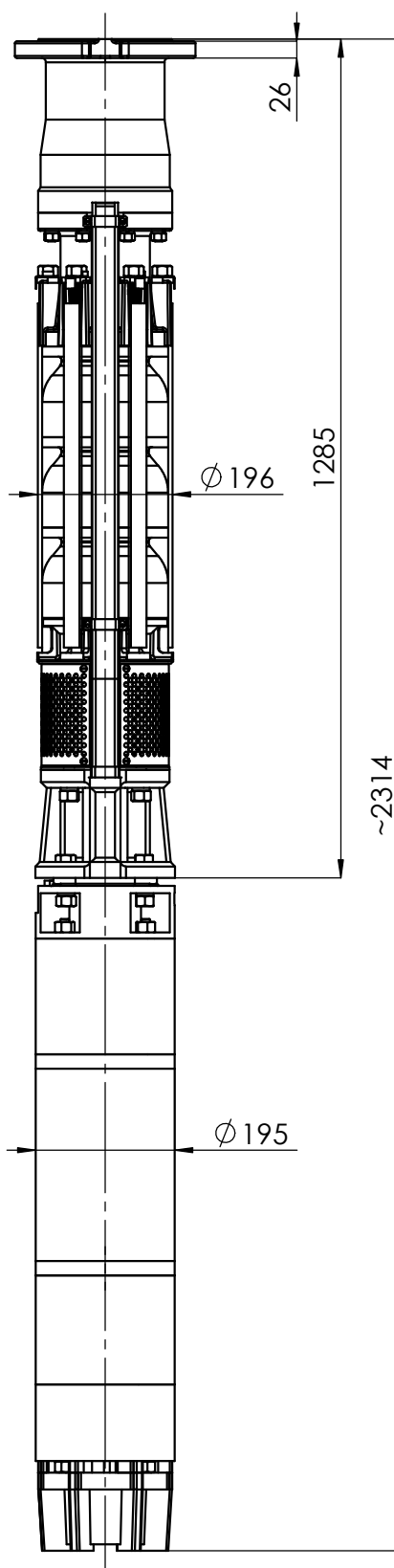
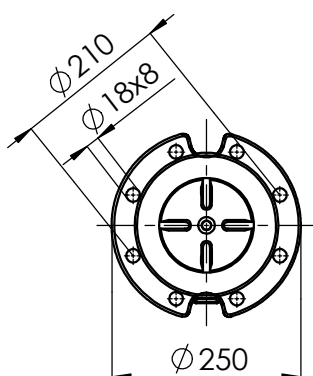
masa/weight/вес: ~ 238 kg

GCA.7.04.1110_8_26kW

8"

26kW

400/500V

HYDRO-VACUUM S.A.

GRUDZIĄDZ

ul. Droga Jeziorna 8