

# Agregat pompowy OPA.1.09

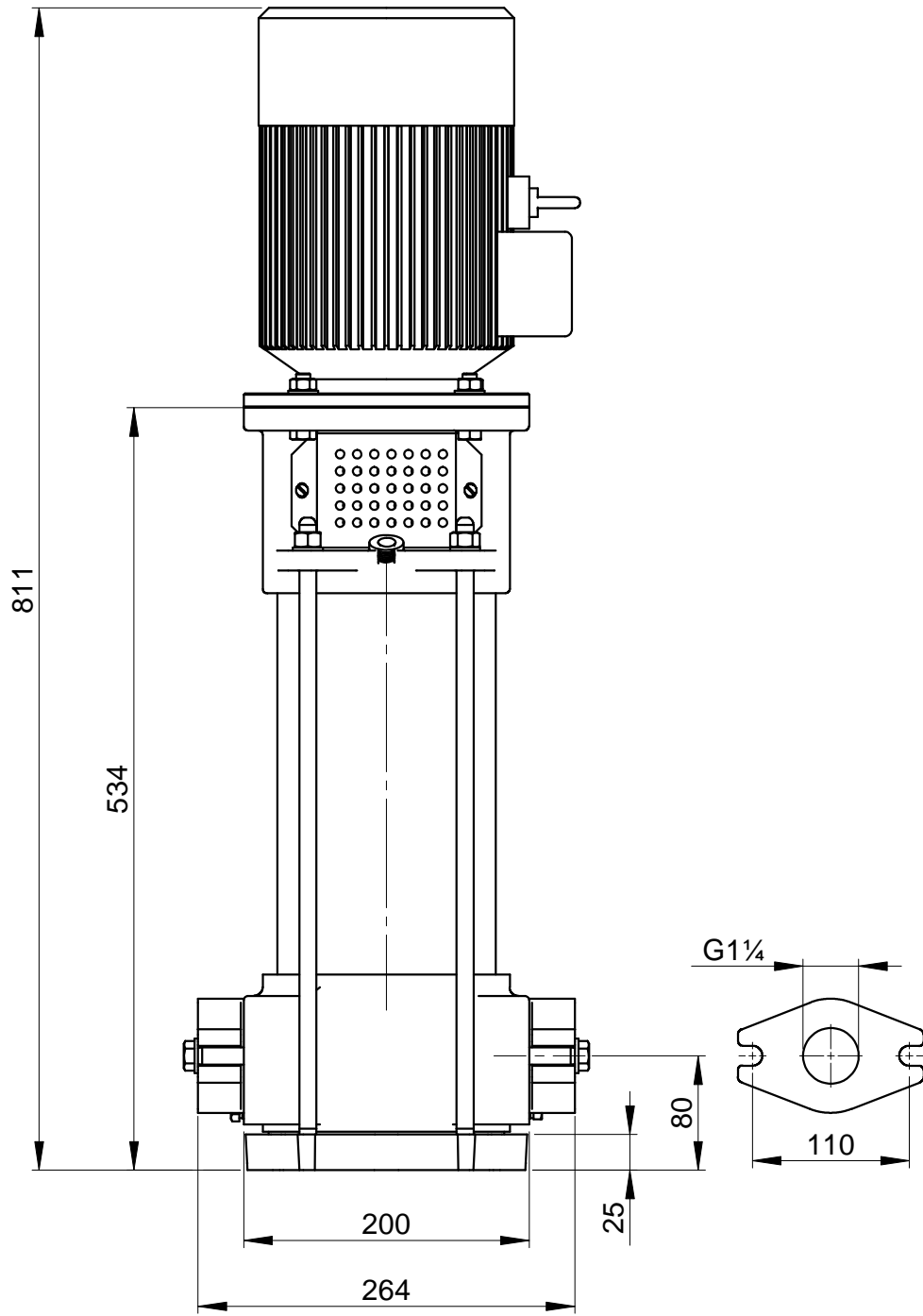

Widok „W”

